



Portable Power Module for Güralp Sensors and Digitisers

Technical Manual

Document No. MAN-CER-1000

Issue A, 13/12/2023 17:15:30

Designed and manufactured by
Güralp Systems Limited
3 Midas House, Calleva Park
Aldermaston RG7 8EA
England

Table of Contents

1 Preliminary Notes	4
1.1 Proprietary Notice.....	4
1.2 Warnings, Cautions and Notes.....	4
1.3 Manuals and Software.....	4
2 Important safety information	5
3 Introduction	6
4 Operation	7
4.1 Hibernation mode	7
4.1.1 Waking the PPM from hibernation.....	7
4.1.2 Putting the PPM into hibernation mode.....	8
4.1.3 Using the web interface	8
4.1.4 Using a diagnostic cable (not supplied)	9
4.2 Working with solar panels	9
4.2.1 Connections and polarities	9
4.2.2 Installation considerations	11
4.2.3 Principle of operation.....	12
4.3 Stand-alone working.....	14
4.3.1 Operation	14
4.3.2 Charging	15
5 Monitoring	16
5.1 Monitoring the PPM	16
5.1.1 Using the web interface	16
5.1.2 Using Discovery.....	16
5.2 Monitoring the solar panel	18
6 Appendices	19
6.1 Understanding Li-ion batteries	19
6.1.1 Charge characteristics.....	19
6.1.2 Temperature issues	20
6.2 Connector pin-outs	21
6.2.1 Charge input	21
6.2.2 Power output.....	22
6.2.3 Charge cable connectors	22

7 Revision History	23
---------------------------------	-----------

for Güralp

1 Preliminary Notes

for Güralp

1.1 Proprietary Notice

The information in this document is proprietary to Güralp Systems Limited and may be copied or distributed for educational and academic purposes but may not be used commercially without permission.

Whilst every effort is made to ensure the accuracy, completeness and usefulness of the information in the document, neither Güralp Systems Limited nor any employee assumes responsibility or is liable for any incidental or consequential damages resulting from the use of this document.

1.2 Warnings, Cautions and Notes

Warnings, cautions and notes are displayed and defined as follows:

Warning: A black cross indicates a chance of injury or death if the warning is not heeded.

Caution: A yellow triangle indicates a chance of damage to or failure of the equipment if the caution is not heeded.

Note: A blue circle indicates a procedural or advisory note.

Other symbols used are defined by their context.

1.3 Manuals and Software

All manuals and software referred to in this document are available from the Güralp Systems website: <https://www.guralp.com/> unless otherwise stated.

2 Important safety information



The GÜralp Portable Power Module (PPM) contains lithium-ion (Li-ion) cells which have an extremely high energy-density. These cells contain a variety of hazardous chemicals. Improper handling and/or disposal can create significant risks, including fire, injury and death.

Studies have shown that physical damage (such as crushing, puncturing or bending), electrical abuse (such as short-circuiting or over-charging), and exposure to elevated temperature can cause a thermal runaway i.e. rapid self-heating from an exothermic chemical reaction. This can, in turn, cause thermal runaway in adjacent cells resulting in a significant risk of fire and release of extremely toxic fumes. This reaction is self-sustaining and does not require oxygen, so it is very difficult to extinguish.

The GÜralp PPM contains protection circuitry to mitigate the risks of over-charging and short circuits. It is nevertheless essential that the following warnings are observed at all times.

- Never puncture, crush or burn a PPM in any condition.
- Do not discard or dispose of an intact or damaged PPM with regular waste. Consult local regulations for disposal procedures.
- Never attempt to open a PPM. There are no user-serviceable parts inside.
- A physically damaged or over-heated PPM presents a significant risk of fire and must be moved immediately to a safe outdoor location. Consult local regulations and/or authorities for further instructions.
- Disconnect the PPM immediately and seek advice if, during operation or charging, it emits any unusual smell, becomes hot, changes shape/geometry or behaves abnormally.
- Never expose the PPM to strong oxidisers, strong acids or conductive fluids, such as sea-water.
- Store the PPM at a temperature between 5°C and 20°C (41°F and 68°F). Do not store next to flammable material.

for Güralp

- If the PPM is to be stored for an extended period, charge it to 50% of its maximum capacity before storage and every six months thereafter.

Portable Power Module for Güralp

3 Introduction

The Güralp Portable Power Module, or PPM, is a convenient charge-control and battery system that can provide continuous power to a Güralp Fortimus or Certimus instrument in a solar-powered installation. It can also be used as a stand-alone battery for short-term, off-grid Fortimus or Certimus deployments.

When used with solar panels, the integrated charge controller operates on the MPPT (Maximum Power Point Tracking) principle and will automatically adjust its input impedance to draw the maximum power from the connected solar panel, regardless of changes in light conditions.



The Portable Power Module is a single, rugged, sealed unit and is supplied with:

- an output cable for connecting it directly to the Fortimus or Certimus. This cable has a four-pin bayonet connector on each end.
- a charge cable. This connects to the PPM via a six-pin bayonet connector and is terminated at the other end in a pair of industry standard MC4 connectors.

Note: The PPM has a sleep mode, during which no power output is provided. This is known as "hibernation". It is shipped in this mode and must be "awakened" before use: see section 4.1 on page 9 for details.

4 Operation

4.1 Hibernation mode

In normal use, the PPM's charge-control and monitoring circuitry consumes a small amount of power. During shipping or storage, this would deplete the battery and, potentially, shorten its life. To prevent this, the PPM has a hibernation mode (also known as "sleep mode")..Almost no power is consumed during hibernation and no power is provided to the output connector.

This section discusses :

- waking the PPM from hibernation mode, which must be done before use; and
- putting the PPM back into hibernation, which is strongly recommended before shipping or storage, in order to prolong the battery life.

4.1.1 Waking the PPM from hibernation

The PPM will wake from hibernation when it senses a DC voltage on its charge input. The voltage must be between +1 V and +30 V and must be of the correct polarity (although the unit itself is protected from reverse-polarity connections).

To wake the PPM, any suitable voltage source can be used, including a multimeter set to "continuity test mode" or "diode test" mode. Note the polarity required.



Once woken, the Power Module's internal charge control and monitoring circuitry will start consuming a small amount of power. At this point, the battery voltage will

Portable Power Module for Güralp

become available at the Power output connector, provided sufficient charge is available in the internal cells.

Note: Before shipping, the unit's internal battery is factory-charged to approximately 50% of its capacity, providing an output of between 7.2 and 7.4 volts. This prolongs the battery life. See section 6.1 on page 23 for more details.

For installations with solar panels, if the panels are exposed to light, simply connecting them will wake the PPM from hibernation.

Caution: Before connecting solar panels to the PPM, please read the notes and instructions in section 4.2 on page 11.

4.1.2 Putting the PPM into hibernation mode

Note: Before putting the PPM into hibernation, arrange for the charge on the unit's internal battery to be approximately 50% of its capacity, providing an output of between 7.2 and 7.4 volts. This prolongs the battery life. See section 6.1 on page 23 for more details.

The PPM can be put into hibernation mode in two ways:

- using the web interface of a connected Certimus; or
- using an RS232 diagnostic cable and a PC with a terminal emulator.

These two methods are described in the following sections.

Note: The diagnostic cable is not normally supplied and must be ordered separately from the PPM.

4.1.3 Using the web interface

When the PPM is powering a Certimus, visit the web page of the Certimus and select the "Power" tab.

Note: The "Power" tab of the Certimus' web interface is only present when the Certimus has been booted with a PM connected.

Left-click on the **Battery Ship Mode** button. This enqueues the shutdown: The PPM will continue to function until the charge input voltage drops below 1 Volt. At this point, communication with the PPM will be lost and the data displayed for it will freeze. The power output will be turned off so, if the Certimus doesn't have power available from PoE on the Ethernet cable, it will power down at this point.

4.1.4 Using a diagnostic cable (not supplied)

The PPM has an RS232 serial console which is available via pins on the Charge Input connector. To access it, a diagnostic cable can be constructed. This cable should connect the RS232 pins on the Charge Input connector (see section 6.2.1 on page 25) to the appropriate pins of the serial port of a PC or laptop running terminal emulation software such as PuTTY or Minicom. Configure the emulator for a line-speed of 115,200 Baud.

Once connected, enter the command

```
bat ship 1
```



If the diagnostic cable is designed to also provide power, the PPM will continue to function until the charge input voltage drops below 1 Volt.

4.2 Working with solar panels

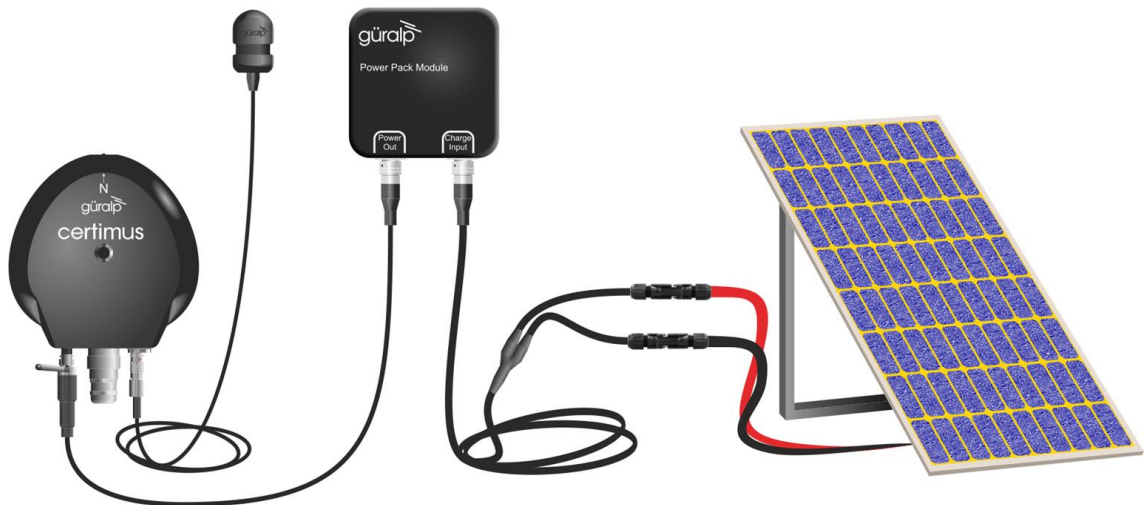

4.2.1 Connections and polarities

Warning: Never connect or disconnect either end of the charge cable while the solar panel is illuminated. When making or breaking DC circuits, an electrical arc may form which can tarnish or damage contact materials, resulting in increased resistance. This can then cause a risk of over-heating, leading to connector damage and, potentially, fire.

The industry standard connector for Solar Panels is the MC4, a single-pole, IP67 weather-proof (when assembled correctly with appropriate cables) connector which is available in two mating forms.

Portable Power Module for GÜralp

Note: While MC4 connectors can be mated by hand, a special tool is required to disconnect them.

Note: If the chosen Solar Panel has different connector polarities or types, an alternative connection method must be chosen. Take care to maintain the IP67 environmental protection of the connections.

Caution: It is important not to confuse the genders of the two connectors. The female-looking body, shown on the left below, actually contains a pin contact and is officially known as the male connector. Similarly, the male-looking body on the right contains the matching socket contact and this is, officially, the female connector. The illustration below shows the contacts above their corresponding connector bodies: male on the left and female on the right.

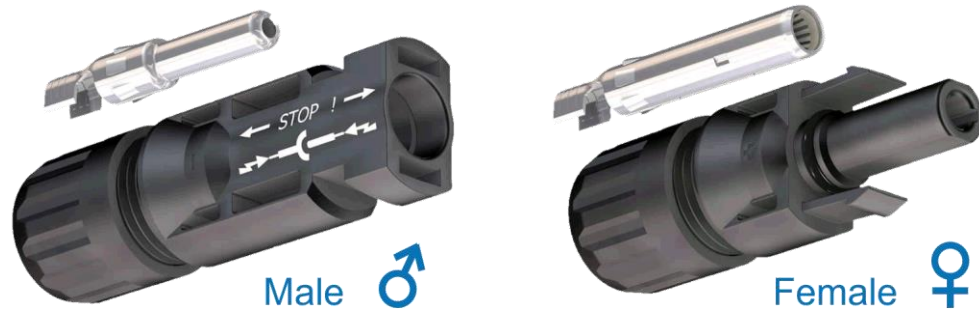

One connector of each type is required for each connection so it is important to distrust any polarity markings ('+' or '-' symbols, red or black bands etc) and check the relevant specifications before connecting.

In standard use, the positive output from the solar panel is terminated with a female connector (see the caution above regarding connector gender) and the negative return is terminated with a male connector.

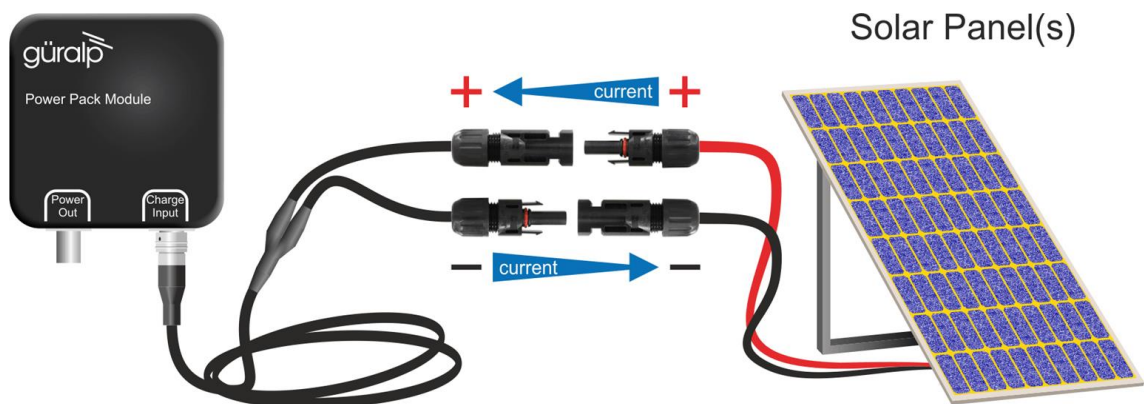

Note: It may be useful to remember that the "nose" of the female connectors points in the direction of flow of conventional current.

4.2.2 Installation considerations

When planning the installation site, consideration should be given to possible electrical storms, wind conditions, local temperature variations and incident light.

These are each discussed in the following sections.

4.2.2.1 Electrical storms

An exposed installation in a region affected by electrical storms requires some form of lightning protection.

Warning: Lightning strikes can cause lethal voltages, very high currents and risk of fire. If in any doubt, seek professional advice when installing in affected regions.

Caution: No electrical equipment can withstand a direct hit from a lightning strike. Even strikes some distance from the installation can cause serious damage in two ways: induced currents in electrical connections and voltage differences between ground points caused by high currents flowing through the earth. In general, only partial protection can be provided.

One method of partial protection consists of a lightning rod: a conductive target mounted on a mast. The target is connected via a high-ampacity cable to a ground point. In the event of a lightning strike, extremely high currents can flow to ground, causing significant horizontal voltage gradients. For this reason, the grounding point for the lightning rod should be as far as practical from the grounding point for the seismic installation and the installation should have only one ground point.

A lightning rod provides a cone of protection with a radius equal to its height.

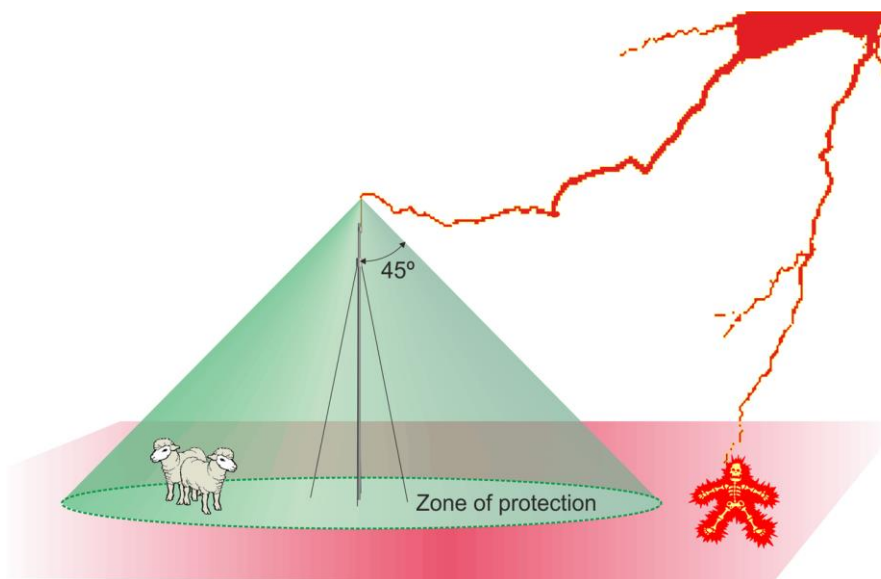

for Guralp

4.2.2.2 *Wind considerations*

Solar panels exposed to winds cause vortices and eddies downwind of the panel. These can couple to the ground, creating earth movements which can be detected by seismometers. For this reason, the solar panel(s) should be installed a suitable distance away from the instrument's emplacement.

4.2.2.3 *Temperature considerations*

The PPM must be protected from extreme temperatures during operation. If the ambient temperature falls below 0° C or rises above 45° C, charging of the lithium-ion cells inside the PPM will be adversely affected.

If the chosen installation site may get too cold, thermal insulation around the PPM may maintain its temperature by trapping its own operational heat energy. If the site may get too hot, burial of the PPM may be required to protect the PPM from direct sunlight.

For more information, please refer to section 6.1.2 on page 24.

4.2.2.4 *Incident light*

To maximise the chance of harvesting energy, the panel should be aligned so that the surface is perpendicular to the incident sunlight. As the sun traverses across the sky during the day, however, the instantaneous optimum alignment will change. A compromise alignment needs to be chosen to maximise the total energy captured across the deployment duration. There are many on-line 'Solar Panel orientation calculators' available which can provide information regarding the best orientation of the panel, given the location and season.

When deploying in winter, note that the amount of foliage on surrounding plants and trees can increase dramatically in the spring and summer. Take care not to choose a location which could end up being in shadow.

4.2.3 Principle of operation

4.2.3.1 *Charge curves*

Solar panels provide energy at different rates during daylight periods, depending on the intensity and angle of the incident light, and not at all during darkness. The total energy provided by the solar panels, summed over a day, must be higher than that required by the Certimus and any ancillary equipment, also summed over a day. If the length of a day is likely to vary over the lifetime of the deployment, this must also be taken into consideration. For this reason, the nominal power - expressed in Watts - of the required solar panel(s) will be considerably higher than the average power draw of the connected equipment.

Portable Power Module for Gralp

In the graph below, the incoming power from the solar panel(s) is shown as the red curve and the outgoing power for the instrumentation and ancillaries is shown by the green curve. Total energy is the integral of power with respect to time so it is represented by the areas under the curves. The area under the red curve must be more than the area under the green curve for the installation to be feasible. If this is not the case, a larger, more powerful panel must be used or additional panels installed.

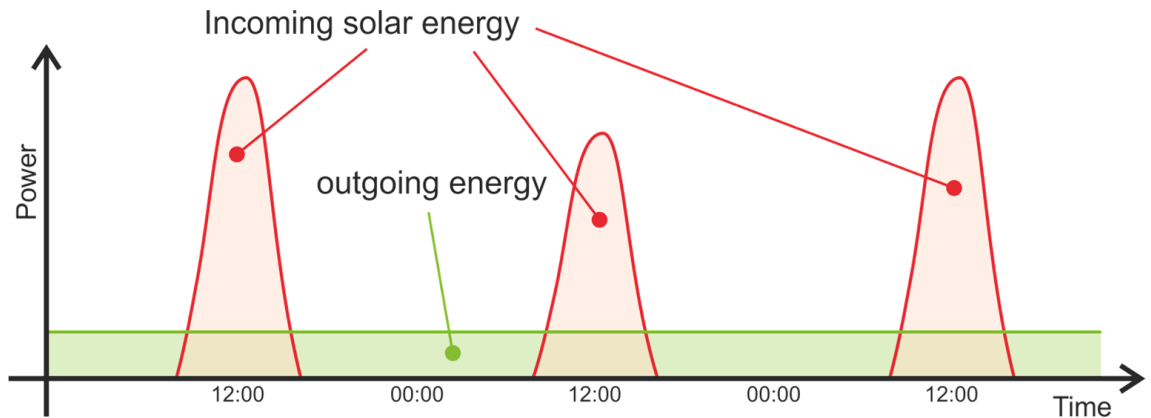

The PPM's battery will be charging whenever the red curve is above the green curve (unless it is already fully-charged) and discharging whenever it is below it.

We can overlay a third curve showing the percentage charge of the battery. This is proportional to the amount of energy stored and is shown by the blue curve below:

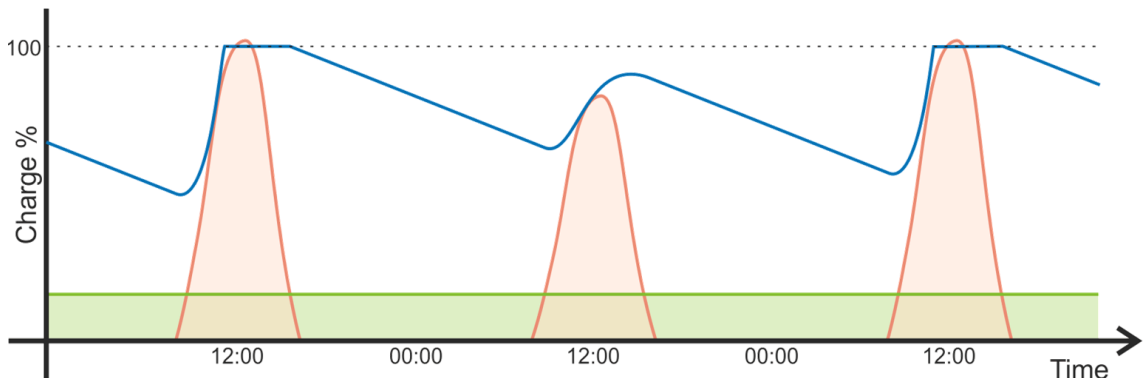

It can be seen that, in this example, the second day has not provided enough energy to fully charge the battery but the third day has provided more than enough to compensate.

The PPM is designed for use with "12 volt" solar panels. Note that this is a nominal voltage and the actual output of the panel will vary between zero and around 18 volts.

Caution: The voltage input to the PPM must never exceed 32 volts.

The PPM is designed to work with a wide range of 12 volt solar panels. Modern, mono-crystalline photovoltaic panels are recommended for their high efficiency.

for Güralp

Flexible “roll up”, semi-flexible and foldable versions are available, which can significantly simplify installations with poor accessibility.

4.2.3.2 *Maximum Power Point Tracking*

Nominal 12 volts panels typically output around 18 V when operating in strong light. This voltage will drop under load because solar panels have an inherently high source resistance. This makes them sensitive to the amount of current drawn from them. For any given light condition, if too much current is drawn, the output voltage will drop to a low level and, because energy varies with the square of the voltage, the amount of energy harvested will decrease dramatically.

For this reason, the PPM has an integrated MPPT (Maximum Power Point Tracking) charge controller and will automatically track the panel's optimum operating point to ensure that it harvests energy at the maximum achievable level of power, regardless of changing light conditions. It does this by adjusting its own input impedance, which determines the current drawn from the panel. The PPM can attain a maximum instantaneous charge input power of approximately 80 Watts. The input current is limited to 8 A.

4.3 Stand-alone working

4.3.1 Operation

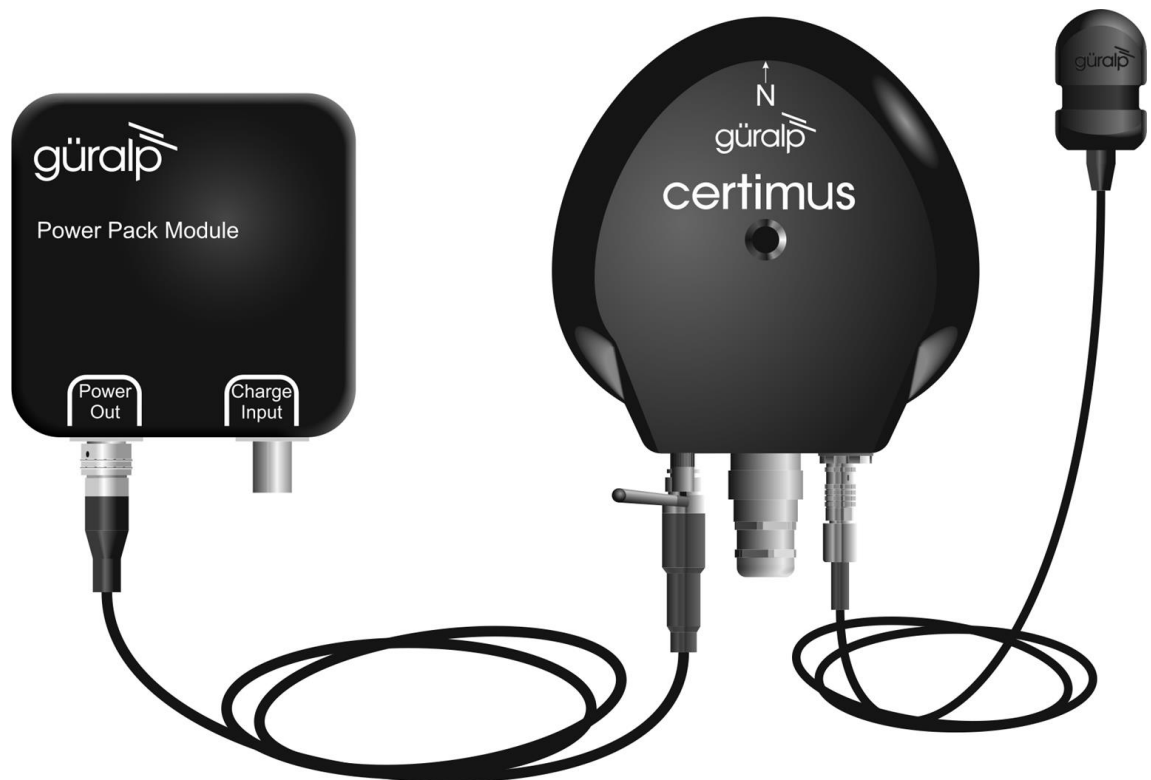

The PPM can be used to provide power to a Certimus without using solar panels. In this mode, the PPM will continue to provide power until its battery voltage reaches 6 V, at which point it will automatically shut itself off in order to protect the cells from damage.

Note: If the PPM is operated until it has shut itself down due to low battery voltage, it must then be recharged to at least 6.4 V before the output power is turned on again.

The initial charge on the battery limits the duration of the deployment so it is important to fully charge the PPM prior to installation. This maximises the "up-time" of the system. Monitor the supplied current when charging the PPM: this will fall to zero and charging will automatically stop when the battery voltage reaches approximately 8.4 V.

Provided that the PPM has sufficient charge and has been woken up (see section 4.1.1 on page 9), it is only necessary to connect the PPM's Power Out to the Certimus' Power Input (using the supplied cable). The PPM will then immediately output power to the Certimus without requiring further action.

4.3.2 Charging

The PPM can be charged using an DC power supply capable of providing a voltage between approximately 10 and 32 volts. The PPM is fitted with over-voltage protections so, if the input voltage exceeds 36 V, charging will be disabled in order to protect the cells.

Note: Because of the MPPT function (see section 4.2.3.2 on page 16), if the input voltage is suddenly reduced, the input current may drop to zero for a short period while the MPPT controller adjusts the input impedance to suit.

Caution: If the PPM has been left totally discharged for a very long time, it will need to be reconditioned in order to avoid damaging the cells. The reconditioning process involves structured charging with a very low initial current. Please seek advice in this situation.

4.3.3 Powering Accessory Devices

The PPM is populated with Lithium Ion cells configured as 2S. The operating voltage of the battery is thus from approx. 5.5V to 8.4V.

This voltage range is obviously less than traditional "12V" lead acid batteries. Guralp sensors and digitisers that are 'Lithium aware' will operate within this voltage range at increased efficiency that the lower voltage offers. They also operate at traditional 10-36V.

The PPM instrument supply come directly from the Lithium battery. There is also an accessory output at a nominal 12V for accessory items such as Modems. This output can be turned on/off from the instrument's web page. Options exist for doing this at specific times of day so allowing limited battery capacity to be used efficiently.

In order to use the timed options, the **Accessory Power** menu item should be set to 'timed'. The **Accessory Type** option, when set to 'modem' will automatically disable the Network of the instrument when the modem is off, so further saving power.

Turn on with CAP is an option that will enable the modem when a CAP message is sent. CAP messages are typically used as a result of a trigger. See 'Triggering' section of the respective instrument manual.

5 Monitoring

5.1 Monitoring the PPM

Monitoring the PPM during the initial days of an installation is essential for understanding whether sufficient power provision has been achieved. By following the cyclical daily state of charge, it will become evident whether the solar energy harvested throughout the day is sufficient to maintain the battery in a good state of charge; it is also possible to obtain an approximate idea of the time for which the power to the Certimus could be maintained if no solar energy were available.

In medium or long-term installations, the battery will support operation during poor light conditions until better light conditions allow re-charging of the battery. The location's latitude and climate will restrict the operational possibilities for any given rating of solar panel. If in doubt, seek local advice where possible.

The operation of the PPM can be monitored using the web interface of the Certimus or by streaming data from the Certimus to a copy of Discovery.

5.1.1 Using the web interface

The condition of the Power Pack Module can be monitored on the "Power" tab of the instrument's web-page. For this tab to be present, the Certimus or Minimus2 must have been booted up with the PPM connected.

The screenshot shows the web interface for a Minimus Lite device. At the top, there is a navigation menu with tabs: Status, Network, Setup, Power (selected), Trigger, Data Stream, Data Record, Storage, Login, and Help. Below the menu, system information is displayed: System type: Minimus Lite | Host label: TIME TEST 4 | Host name: MINL-66F9 (10.30.0.20) | Serial number: 66F9. The main content area is divided into two sections: "Power Supply Status" and "Accessory Power Control".

Power Supply Status

Battery Status	
Version	1.3-148
Total Capacity	34.190 Amp Hrs
Capacity	98%
Volts	8.219 Volts
Current	-858 milli Amps
Life	1 Days 13 Hrs

Below the table is a "Battery Ship Mode" button.

Accessory Power Control

Accessory Power	On	Accessory Type	Modem	<input checked="" type="checkbox"/> Turn on with CAP			
Start Time 1 (hrs-mins)	10:00	End Time 1 (hrs-mins)	11:00	Start Time 2 (hrs-mins)	16:00	End Time 2 (hrs-mins)	17:00
On-Time	300 s	Min Off-Time (hrs-mins)	06:00	Max Off-Time (hrs-mins)	24:00	Minimum Battery Percentage	80

At the bottom of the interface, contact information for Güralp Systems Limited is provided: Midas House, Calveya Park, Aldermaston, Reading, RG7 8EA, UK. Tel: +44 118 981 9056, Fax: +44 118 981 9943. E-Mail: sales@guralp.com, support@guralp.com.

Note: The current shown is the total current flowing into the PPM. If the battery in the PPM is being charged, the current will be shown as positive. If the connected Instrument is drawing more current than the charge input can supply (or if there is no charging input) the current will be shown as negative.

5.1.2 Using Discovery

The condition of the Power Pack Module can be monitored using live data streams within the Güralp 'Discovery' application.

Using Discovery, open the "Live View > GDI" window. Provided that the Certimus was connected to the PPM when it booted, the Channel List will include an entry for "Battery". Tick the corresponding check-boxes to select any of the six available channels of data from the PPM for streaming and/or display.

The available channels are:

- BattCharge : Battery coulomb count which at power-on is initialised to a value approximated from the battery voltage measured. This will effectively count charge in and out of the battery to give an approximate running state of charge of the battery. Subsequent to power-on, the value gets re-initialised whenever the battery becomes fully charged.
- BattChargeI : The current flowing into the Charge Input. Always positive.
- BattChargeV : The voltage measured at the Charge Input.
- BattCurrent : The current flowing into the battery. This is positive when the battery is being charged and negative otherwise.

Note: Note that this may be negative even when power is being extracted from the solar panel(s). This will happen when the instrument is drawing more power than the panel(s) can supply.

- BattTemp : Temperature of the control device in the PPM.
- BattVoltage : Battery Voltage.
- BatteryPower: Power into (+ve) out out of the battery (-ve)

The stream-selection tree is shown below:

Portable Power Module for Guralp

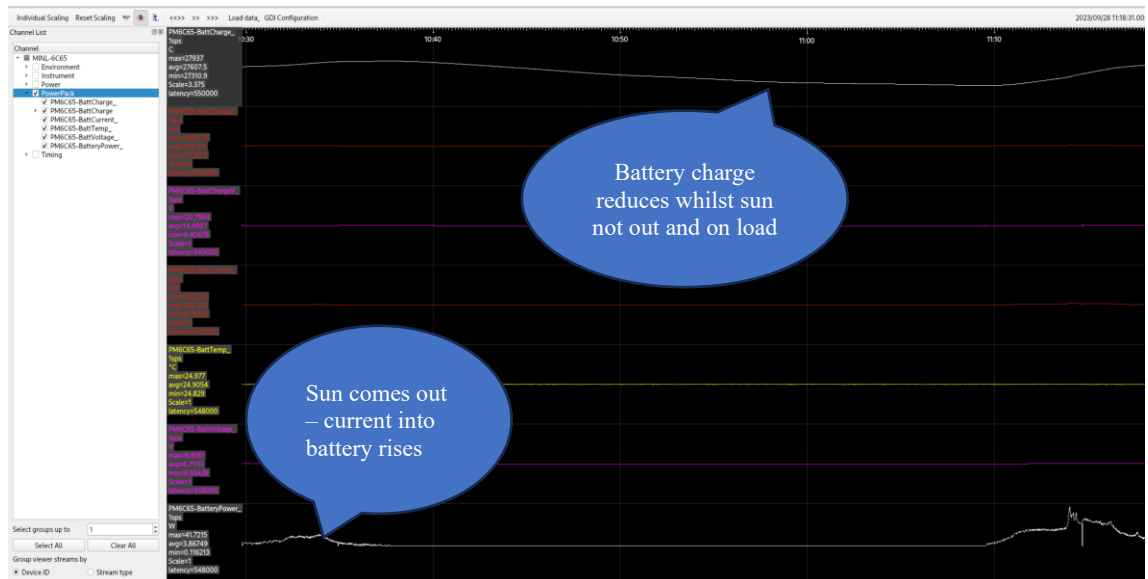

Figure 1 Streams as seen from Discovery

5.2 Monitoring the solar panel

During installation, it may be convenient to monitor the charging performance directly. This can be done using a solar panel analyser - sometimes called a Watt/Volt meter - connected in-line between the panel and the PPM. Such panel analysers are not supplied with the PPM but are commercially available from many sources.

Such meters typically display the following parameters:

- Solar panel output voltage, measured in volts.
- Instantaneous charging current, measured in amps.
- Instantaneous solar power - the amount of power which the panel is currently providing, measured in watts.

The meter shown below also displays the instantaneous power integrated over time, measured in watt-hours (Wh), where one watt-hour equals 3,600 Joules. This represents the total energy harvested from the panel.

Portable Power Module for Güralp



If the chosen analyser is not fitted with MC4 connectors, it can still be used by constructing or purchasing appropriate adaptors. Alternatively, the analyser itself can be modified by fitting MC4 connectors in place of the existing connectors.

6 Appendices

6.1 Understanding Li-ion batteries

6.1.1 Charge characteristics

The Power Module uses a battery of rechargeable lithium-ion (Li-ion) cells. These have a good capacity/volume ratio and are commonly used in, for example, electrically-powered vehicles.

As with most cell technologies, a Li-ion cell's terminal voltage depends on its state of charge. The graph below shows the relationship between the cell terminal voltage and the extent to which the cell has been discharged. Note that the graph does not extend down to zero volts: the curve is actually very flat across the majority of charge states - much more so than for a lead-acid battery, for example. The terminal voltage varies by less than 0.3 V between 20% and 80% charge.

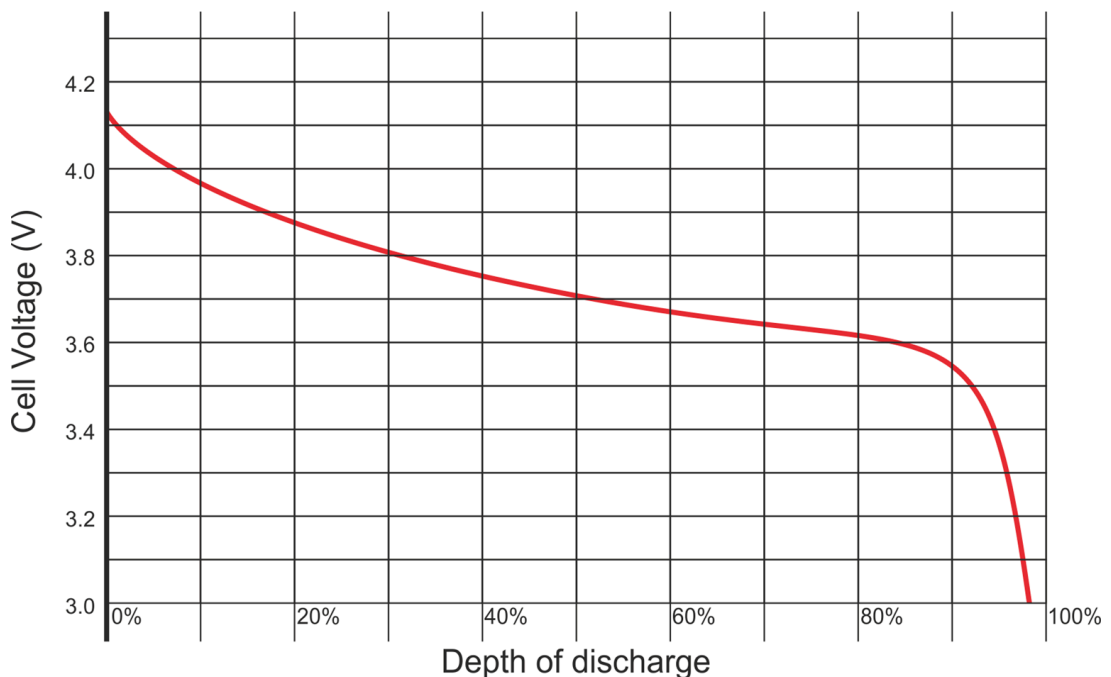

Each cell provides a terminal voltage in the range 2.5 V to 4.2 V. Only the useful part of the operating curve is shown above. Once discharged down to 3 V, very little of the available charge is left. If the cell is discharged below this point, internal damage starts to occur because of the chemistry involved. This process accelerates if the cell is discharged to below 2.5 V. If left in this condition for a long period of time, the internal cell damage can make it dangerous to recharge at any more than a very small recovery current because of the internal heating effects.

Portable Power Module for Güralp

To protect the cells from this damage, the PPM's control system will turn off the power output if the cell voltage drops below 3V. The system will then enter a low-power mode to preserve any remaining charge for as long as possible. If charging resumes, the PPM will monitor the cells until a terminal voltage of 3.2 V is reached, at which point the power output will be turned on again.

Note: To maintain continuous operation of the connected instrument, it is important that the cell voltage is monitored and the installation planned so that the cell voltage does not fall below 3 volts.

The Li-ion cells used in the Power Module are connected in "2S" (i.e. "2 Series") configuration which means that two banks of cells are connected in series, as in the simplified diagram below. Because of this, the output voltage is twice that of each individual cell's terminal voltage.

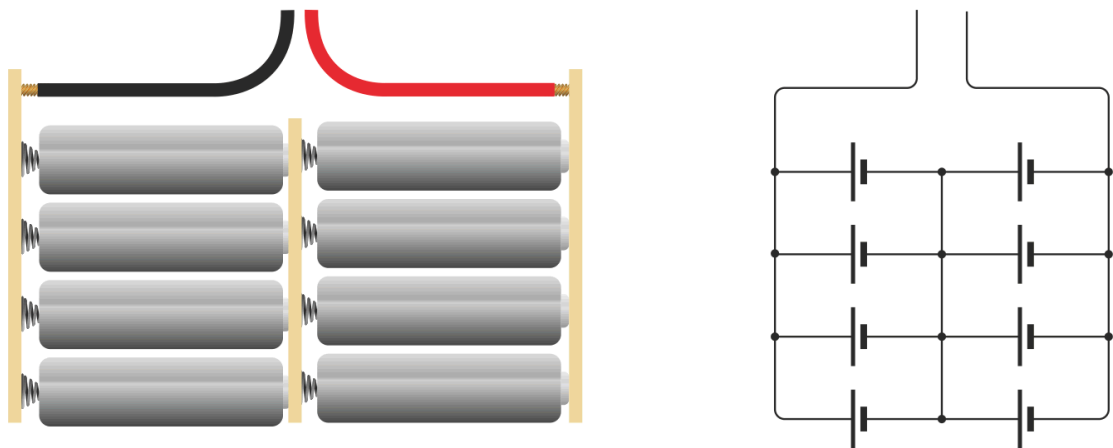

(There is a third connection, not shown above, to the intermediate contact between the two sets of cells. This is used to monitor and adjust the balance of charge between the two banks.)

6.1.2 Temperature issues

It is important to understand the operational limits of Li-ion cells with regard to the temperature conditions at the intended installation location. Note that the acceptable temperature ranges for charge and discharge differ.

Discharge of the cells (i.e. the PPM's ability to provide power to an instrument) is specified over the range -20°C to $+60^{\circ}\text{C}$. Charging, however, is specified ONLY over the range 10°C to $+45^{\circ}\text{C}$.

The PPM monitors its own temperature and controls charging accordingly. Charging will be restricted or even disabled when the temperature approaches or exceeds the operational limits. The maximum charging rate is only available when the temperature is in the range $+10^{\circ}\text{C}$ to $+40^{\circ}\text{C}$.

for Güralp

The PPM simultaneously limits the charge input current to approximately 8 Amps and the input power to around 80 Watts. As the cell voltage attains its maximum voltage (4.2V) the charging rate is reduced accordingly. Even if available power is at a maximum, it cannot allow further charging of the cell for safety reasons.

6.2 Connector pin-outs

6.2.1 Charge input

These are standard 6-pin military-specification bayonet sockets, conforming to MIL-DTL-26482 (formerly MIL-C-26482). A typical part-number is 02E-10-06S although the initial "02E" varies with manufacturer.

Suitable mating connectors have part-numbers like ***-08-06P and are available from Amphenol, ITT Cannon and other manufacturers. We recommend Amphenol part number 62GB-56T10-06PN-416



Pin	Function
A	Charge input - Negative and RS232 Ground
B	Charge input - Positive
C	Diagnostic RS232 TxD (output).
D	Diagnostic RS232 RxD (input)
E	Accessory power output - Negative and RS232 Ground
F	Accessory power output - Positive, 12 V DC. If more than 1900 mA is drawn, this output will be disabled until the current falls to zero.

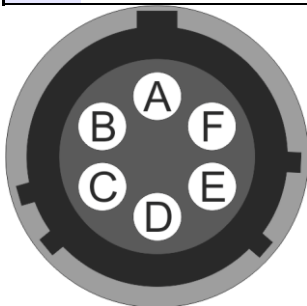

Wiring details for the compatible plug, ***-10-06P, as seen from the cable end (i.e. when assembling).

for Güralp

Note: Very early units exposed the internal "2S" cell voltage on pin F and the associated current limiter was set to 900 mA. Units produced after June, 2021 include a 12 V boost converter to provide a uniform output voltage and the current limit has been increased to 1900 mA (1.9 A).

6.2.2 Power output

These are standard 4-pin military-specification bayonet sockets, conforming to MIL-DTL-26482 (formerly MIL-C-26482). A typical part-number is 02E-08-04S although the initial "02E" varies with manufacturer.

Suitable mating connectors have part-numbers like ***-08-04P and are available from Amphenol, ITT Cannon and other manufacturers. We recommend Amphenol part number 62GB-56TGUWSB108-04PN-416



Pin	Function
A	Instrument communications RS232 RxD (input)
B	Instrument communications RS232 TxD (output)
C	Instrument power output - Negative.
D	Instrument power output - Positive. If more than 1.9 amps is drawn, this output will be disabled until the current falls to less than 500 mA.

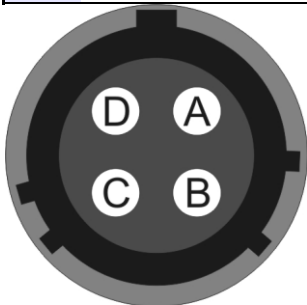

4-way plug,
from cable side

Wiring details for the compatible plug, ***-08-04P, as seen from the cable end (i.e. when assembling).

6.2.3 Charge cable connectors



for Güralp

The Güralp PPM uses MC4 connectors (manufactured by Stäubli Electrical Connectors) for connection to the solar panels. See section 4.2.1 on page 11 for polarity details. Suitable mating connectors include MC4, Amphenol Helios H4 and SMK PV-03.

Portable Power Module
for Güralp

7 Revision History

A	2021-05-24	Initial release
---	------------	-----------------